

INPHENIX

SLD Light Source Desktop

Part Number: IPSDM0905-xxxx

1. Configuration

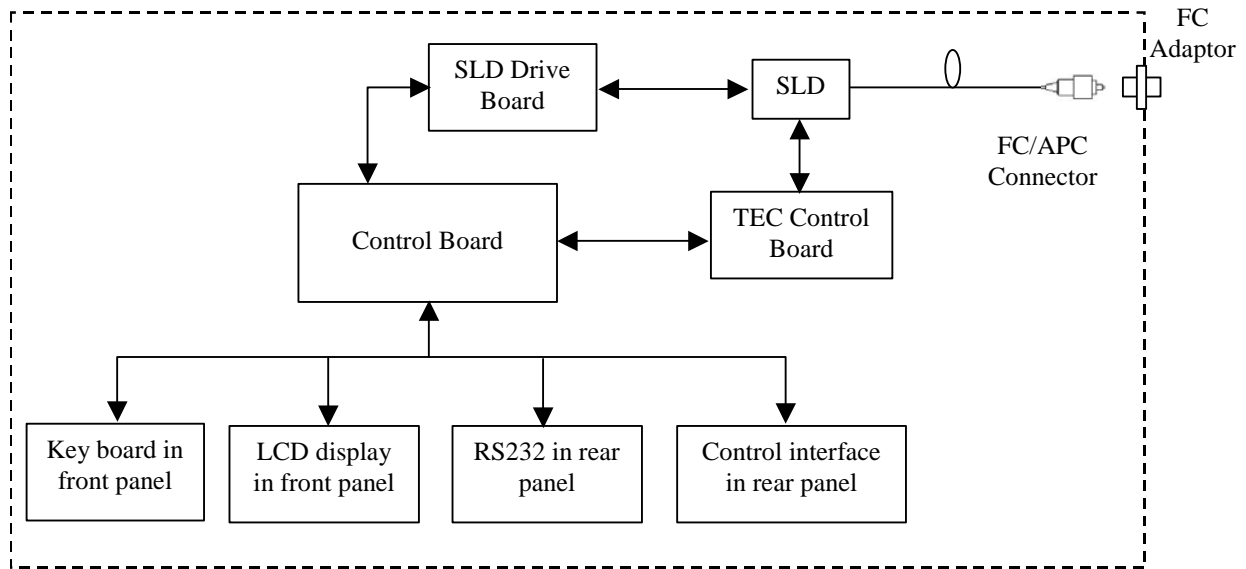

Figure 1 Configuration of IPSDM0905-xxxx SLD light source desktop

2. Absolute Maximum Ratings

Parameter	Min.	Typ.	Max.	Unit
Power Supply Voltage	100	-	240	VAC
Storage Temperature	-40	-	+85	°C
Humidity	10	-	100	%

3. Recommended Operational Condition

Parameter	Min.	Typ.	Max.	Unit
Operating Temperature	10	25	35	°C
Operating Humidity	30	60	75	%

INPHENIX

4. Optical characteristics

Items	Specifications			Unit	Notes
	Min.	Typ.	Max.		
Center Wavelength (at center of FWHM)	900	920	940	nm	@ 25°C, CW optical output and optical connector included.
3dB Optical Bandwidth	90	100	-	nm	
Optical Output Power	3	5	-	mW	
ASE Ripple @ 0.1nm	-	0.1	0.2	dB	
Optical Power Stability (8hr)	-	-	±0.1	dB	Stability test of P _{max} after 0.5 hour warm up at 25°C
Optical Interface	FC Female Adapter			-	
Fiber Connector	FC/APC			-	
Optical Isolator	None included			-	
Fiber type	SMF/PMF/MMF			-	

5. Electrical characteristics

Item	Specifications			Unit	Notes
	Min.	Typ.	Max.		
Power Control	Current control for SLD			-	Press keyboard in the front panel manually, or via RS232 by computer.
SLD Drive Current Monitor	SLD drive current display on Screen			-	Or get data through RS232.
Keyboard lock	Lock & Key switch for front panel buttons' activation			-	A keyboard disable switch in the rear panel.
Connector for RS232	DB9 Connector, Male.			-	In the rear panel
Connector for Control	DB9 Connector, Female.			-	



6. Physical Dimensions and Mechanical Specifications

Size: 344mm(W)×260mm(D)×90mm(H)

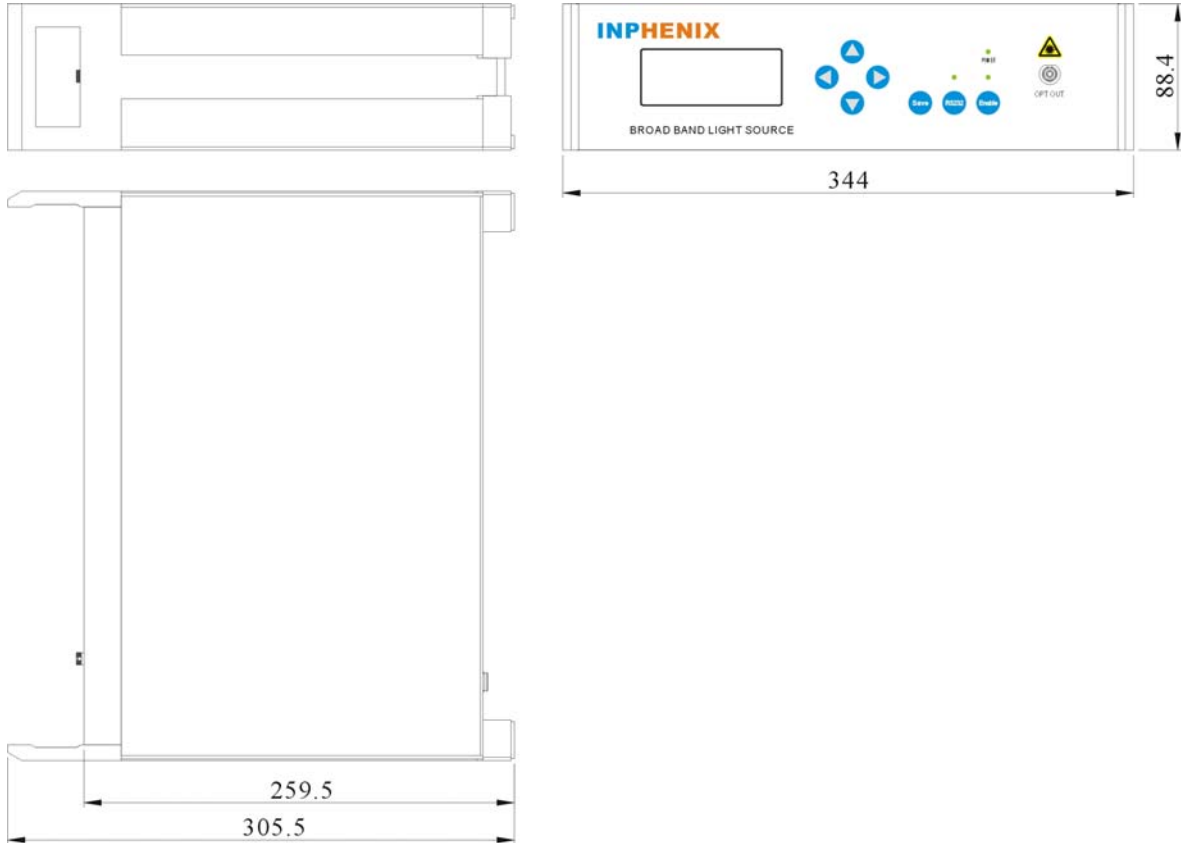

Figure 2 Mechanical drawing of IPSDM0905-xx8 SLD light source desktop

INPHENIX

7. Part Numbering Structure of SLD light source desktop



Model Number

- 07** : 700~790nm SLD
- 08** : 800~890nm SLD
- 09** : 900~990nm SLD
- 10** : 1010~1090nm SLD
- 13** : 1300~1390nm SLD
- 14** : 1400~1490nm SLD
- 15** : 1500~1590nm SLD

Output Type

- 0: FC Adaptor
- 1: Pigtail fiber

Connector Type

- 0: No Connectors
- 3: FC/APC 4: FC/UPC
- 7: SC/APC 8: SC/UPC

Fiber Type

- 1: SM Fiber
- 2: PM Fiber
- 3: MM Fiber

Case Size

- 8: 344×260×90mm case
- 9: 450×300×90mm case

Example: IPSDM0701-0318: 700nm-type SLD light source desktop in 344×260×90mm case with FC adaptor output, 900μm SM fiber with FC/APC connector.

Corporate Office

250 North Mines Rd
 Livermore, CA 94551
 Tel: 925.606.8809
 Fax: 925.606.8810
www.inphenix.com
sales@inphenix.com