

INPHENIX

Super-Luminescent Light Emitting Diode Device

IPSDD1008 (1050nm)

Features

- Wide Optical Bandwidth
- Very Low Spectral Ripple
- High Output Power in SM or PM Fiber

Applications

- Broadband Light Source
- Fiber Optic Sensor (FOS) Systems
- Biomedical Imaging Device
- Optical Coherence Tomography (OCT)



Device Specifications

Parameter	Symbol	Min.	Typ.	Max.	Unit
Central Wavelength	λ_c	1040	1050	1065	nm
3dB Bandwidth	$\Delta\lambda_{3dB}$	40	45	-	nm
Output Power in SM Fiber	P_o	30	35	-	mW
Spectral Modulation Depth _{p-p}	Δ	-	0.2	0.5	dB
Operating Current	I_F	-	400	500	mA
Back Facet Monitor	Available upon request				

Absolute Maximum Ratings

Parameter	Min.	Max.	Unit
Operating Temperature	- 20	70	°C
Storage Temperature	- 40	85	°C
TEC Drive Current	-	1.5	A
TEC Drive Voltage	-	3.6	V
Maximum Current	600		mA
Thermistor Resistance	10k Ω @ 25°C		
SLD Chip Temperature Setting	25°C		
Fiber Type	SMF/PMF/MMF		
Fiber Jacket	250 μ m tight buffer with 900 μ m loose tube		
Package	14-pin DIL/14-pin BUT/8-pin BUT		
Lead Solder Temperature	260°C for 10 Seconds		

INPHENIX

Package Dimensions

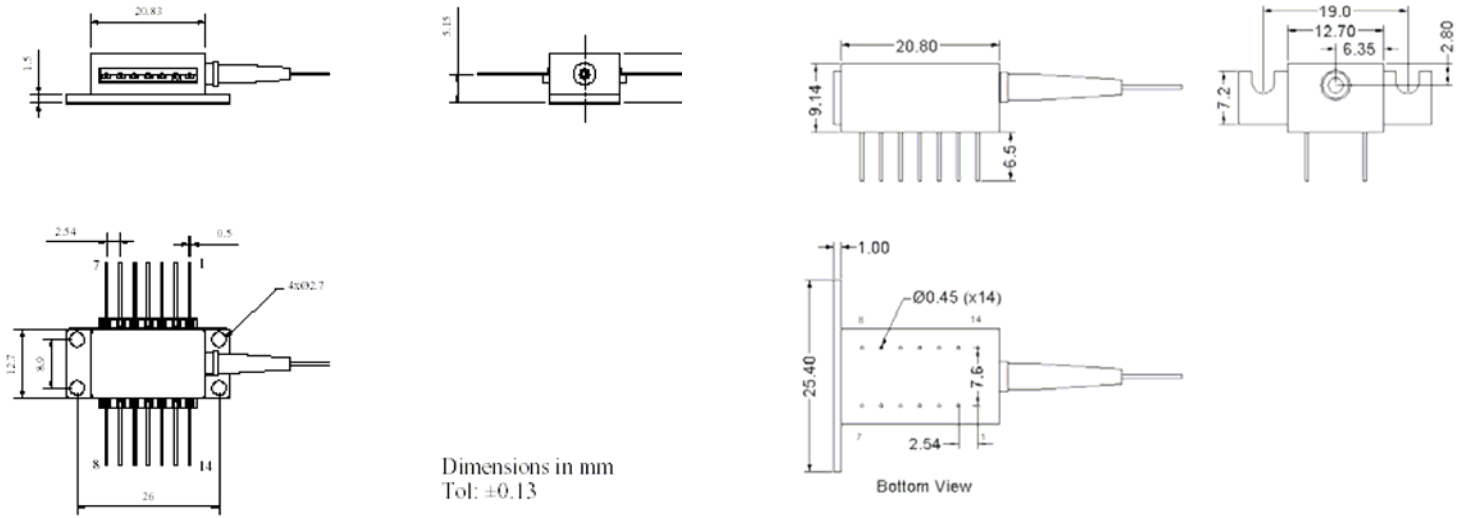

14-Pin BUT Package

14-Pin DIL Package

Pin Definition

14-pin BUT package				14-pin DIL package			
Pin	Function	Pin	Function	Pin	Function	Pin	Function
1	TEC (+)	8	NC	1	TEC (+)	8	NC
2	Thermistor	9	NC	2	NC	9	SLD (-)
3	NC	10	SLD (+)	3	NC	10	Case
4	NC	11	SLD (-)	4	NC	11	Thermistor
5	Thermistor	12	NC	5	SLD (+)	12	Thermistor
6	NC	13	Case	6	NC	13	NC
7	NC	14	TEC (-)	7	NC	14	TEC (-)

- If the SLD is ordered with a Back Facet Monitor, Pin 7 is PD-Cathode and Pin 8 is PD+Anode

INPHENIX

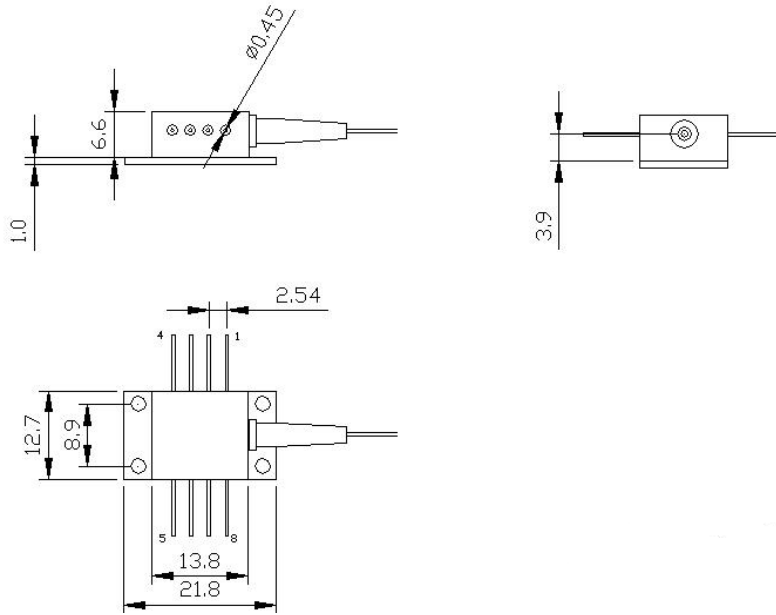

8-Pin BUT Package

Pin Definition

8-pin BUT package	
Pin	Function
1	TEC (+)
2	NC
3	NC
4	SLED (+)
5	SLED (-)
6	Thermistor
7	Thermistor
8	TEC (-)

INPHENIX

Part Numbering System



Model:

IPSDDXXXX: SLD Device

Package:

- 1: 14-pin DIL
- 2: 8-pin Butterfly
- 3: 14-pin Butterfly

Fiber Type:

- 1: SM Fiber
- 2: PM Fiber
- 3: MM Fiber

Jacket Type:

- 1: 900µm
- 2: 250µm tight buffer

Connector Type:

- 0: No Connector
- 3: FC/APC
- 4: FC/UPC
- 7: SC/APC
- 8: SC/UPC

Back Facet Monitor:

Available upon request

Example: IPSDD0805-1224: 850nm SLD in 14-pin DIL with 250µm tight buffered PM Fiber with FC/UPC connectors

Corporate Office

250 North Mines Rd
Livermore, CA 94551
Tel: 925.606.8809
Fax: 925.606.8810
www.inphenix.com
sales@inphenix.com