

# INPHENIX

## Super-Luminescent Light Emitting Diode Device

### IPSDD1402 (1410nm)

#### Features

- Wide Optical Bandwidth
- Very Low Spectral Ripple
- High Output Power in SM/or PM Fiber

#### Applications

- Broadband Light Source for Insertion Loss Test
- Distributed Fiber Optic Sensor (FOS)
- Biomedical Imaging Device
- OCT Diagnostic System



#### Device Specifications

Parameter	Symbol	Min.	Typ.	Max.	Unit
Central Wavelength	$\lambda_c$	1390	1410	1430	nm
3dB Bandwidth	$\Delta\lambda_{3dB}$	55	60	-	nm
Output Power in SM Fiber	$P_o$	10	15	-	mW
Spectral Modulation Depth <sub>p-p</sub>	$\Delta$	-	0.15	0.35	dB
Operating Current	$I_F$	-	450	500	mA
Back Facet Monitor	Available upon request				

#### Absolute Maximum Ratings

Parameter	Min.	Max.	Unit
Operating Temperature	- 20	70	°C
Storage Temperature	- 40	85	°C
TEC Drive Current	-	1.5	A
TEC Drive Voltage	-	3.6	V
Maximum Current	500		mA
Thermistor Resistance	10k $\Omega$ @ 25°C		
SLD Chip Temperature Setting	25°C		
Fiber Type	SMF/PMF/MMF		
Fiber Jacket	250 $\mu$ m tight buffer with 900 $\mu$ m loose tube		
Package	14-pin DIL/14-pin BUT/8-pin BUT		
Lead Solder Temperature	260°C for 10 Seconds		

# INPHENIX

## Package Dimensions

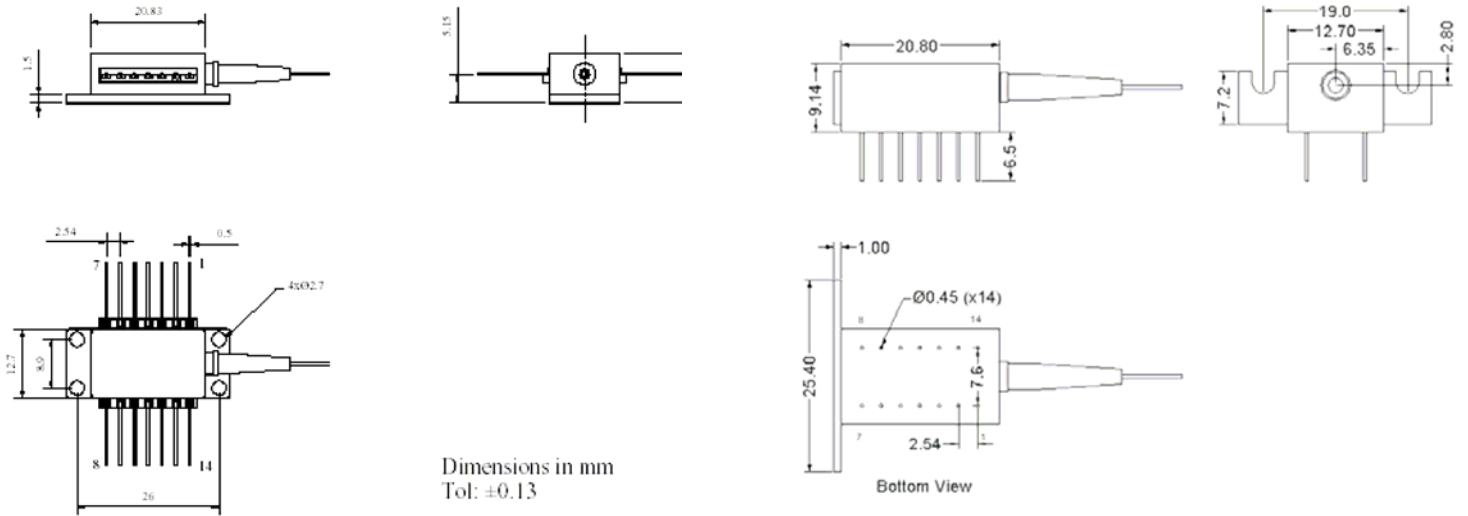

14-Pin BUT Package

14-Pin DIL Package

### Pin Definition

14-pin BUT package				14-pin DIL package			
Pin	Function	Pin	Function	Pin	Function	Pin	Function
1	TEC (+)	8	NC	1	TEC (+)	8	NC
2	Thermistor	9	NC	2	NC	9	SLD (-)
3	NC	10	SLD (+)	3	NC	10	Case
4	NC	11	SLD (-)	4	NC	11	Thermistor
5	Thermistor	12	NC	5	SLD (+)	12	Thermistor
6	NC	13	Case	6	NC	13	NC
7	NC	14	TEC (-)	7	NC	14	TEC (-)

- If the SLD is ordered with a Back Facet Monitor, Pin 7 is PD-Cathode and Pin 8 is PD+Anode

# INPHENIX

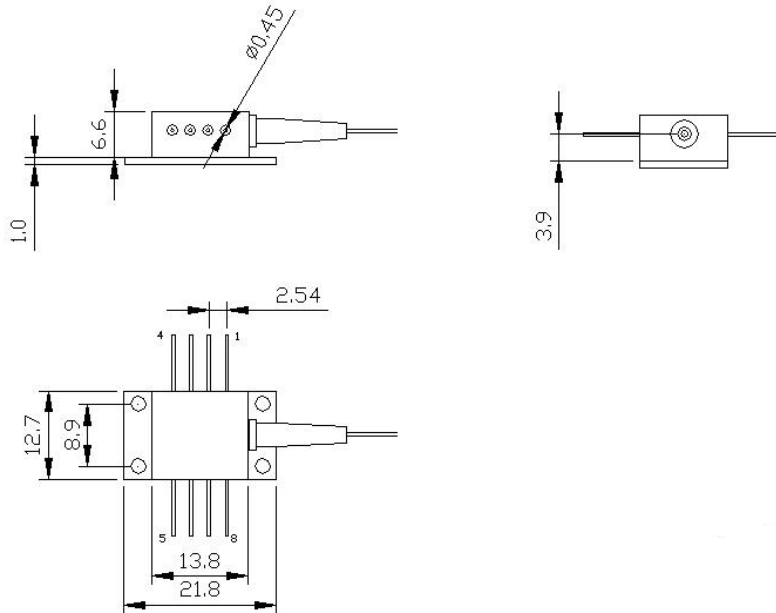

**8-Pin BUT Package**

## Pin Definition

8-pin BUT package	
Pin	Function
1	TEC (+)
2	NC
3	NC
4	SLED (+)
5	SLED (-)
6	Thermistor
7	Thermistor
8	TEC (-)

# INPHENIX

## Part Numbering System



**Model:**

IPSDDXXXX: SLD Device

**Package:**

- 1: 14-pin DIL
- 2: 8-pin Butterfly
- 3: 14-pin Butterfly

**Fiber Type:**

- 1: SM Fiber
- 2: PM Fiber
- 3: MM Fiber

**Jacket Type:**

- 1: 900 $\mu$ m
- 2: 250 $\mu$ m tight buffer

**Connector Type:**

- 0: No Connector
- 3: FC/APC
- 4: FC/UPC
- 7: SC/APC
- 8: SC/UPC

**Back Facet Monitor:**

Available upon request

**Example:** IPSDD0805-1224: 850nm SLD in 14-pin DIL with 250 $\mu$ m tight buffered PM Fiber with FC/UPC connectors

**Corporate Office**

250 North Mines Rd  
Livermore, CA 94551  
Tel: 925.606.8809  
Fax: 925.606.8810  
[www.inphenix.com](http://www.inphenix.com)  
[sales@inphenix.com](mailto:sales@inphenix.com)